

**McLED**<sup>®</sup>

quality lighting

ZAHRADNÍ







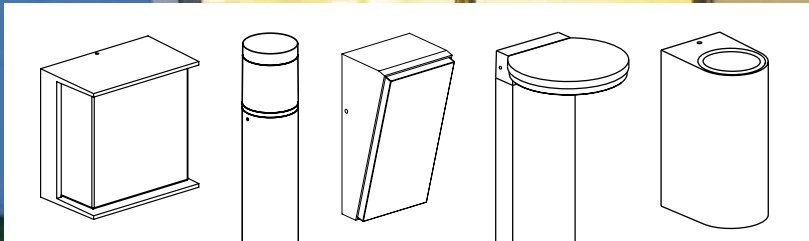























PŘÍSAZENÉ

NÁSTĚNNÉ

STROPNÍ



# LED venkovní osvětlení

	Název		Strana
STROPNÍ	Andromede R		3
	Andromede S		
	Noel R		4
	Noel S		
NÁSTĚNNÉ	Cygnus		5
	Kerberos		
	Draco R		6
	Draco S		
	Ursa R		7
	Ursa S		
	Corona V		8
	Corona H		
	Ether		9
	Leon		
	Kronos		10
	Penelope		
	Revos R		11
	Revos 2R		
	Revos S		
	Revos 2S		
Verona R		12	
Verona 2R			
Verona S			
Verona 2S			
Framus W		13	
Framus P			
ZAHRADNÍ	Thea		14
	Rhea		
	Borg		15
	Kira		



# Andromede R

14 W 220-240 V IP 65 CRI >80 max +60°C min -20°C 30000 h L70



Vysoce kvalitní čipy:



Vysoce kvalitní driver:

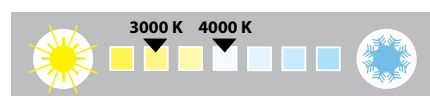
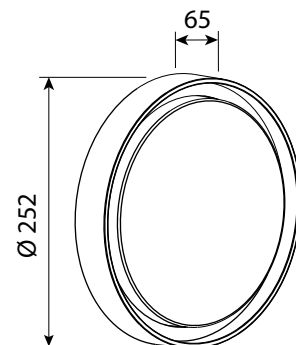

A+

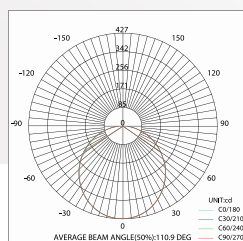
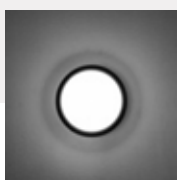

Barva	ML kód	ML typ	Výkon	Vyzař. úhel	Světelný tok	Teplota bílé	PF	IP	Cena Kč*
černá	ML-516.005.19.0	AND-R-14W3000K-B	14 W	110°	1035 lm	3000 K	≥0,5	65	1995,-
	ML-516.006.19.0	AND-R-14W4000K-B			1115 lm	4000 K			

- Hliníkové pouzdro
- Plastový difuzor

\*Uvedené ceny jsou brutto velkoobchodní ceny v Kč bez DPH. Ostatní barevné varianty (bílá, šedá) je možné dodat při objednávce min 30ks.

IP65 CE

# Andromede S

14 W 220-240 V IP 65 CRI >80 max +60°C min -20°C 30000 h L70



Vysoce kvalitní čipy:



Vysoce kvalitní driver:

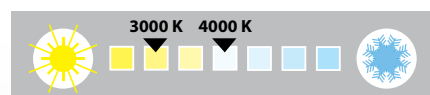
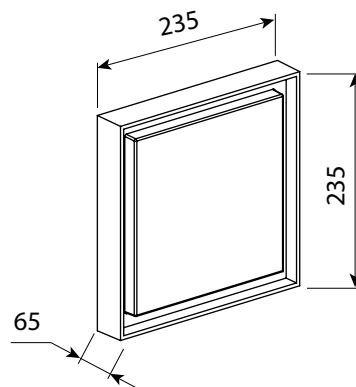

A+

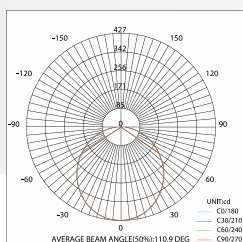

Barva	ML kód	ML typ	Výkon	Vyzař. úhel	Světelný tok	Teplota bílé	PF	IP	Cena Kč*
černá	ML-516.007.19.0	AND-S-14W3000K-B	14 W	110°	1060 lm	3000 K	≥0,5	65	2085,-
	ML-516.008.19.0	AND-S-14W4000K-B			1140 lm	4000 K			

- Hliníkové pouzdro
- Plastový difuzor

\*Uvedené ceny jsou brutto velkoobchodní ceny v Kč bez DPH. Ostatní barevné varianty (bílá, šedá) je možné dodat při objednávce min 30ks.

IP65 CE

# Noel R



Vysoce kvalitní čipy:



Vysoce kvalitní driver:



7 W 220-240 V IP 65 CRI >80 max +60°C min -20°C 30 000 h L70

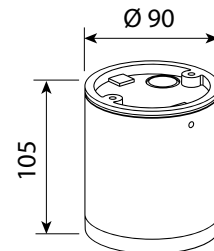

A+

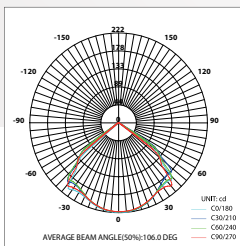

IP65 CE

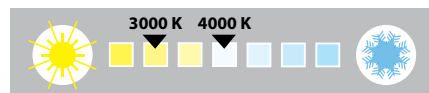

Barva	ML kód	ML typ	Výkon	Vyzař. úhel	Světelný tok	Teplota bílé	PF	IP	Cena Kč*
černá	ML-516.011.19.0	NOE-R-7W3000K-B	7 W	102°	460 lm	3000 K	≥0,5	65	921,-
	ML-516.012.19.0	NOE-R-7W4000K-B			495 lm	4000 K			

- Hliníkové pouzdro
- Plastový difuzor

\*Uvedené ceny jsou brutto velkoobchodní ceny v Kč bez DPH. Ostatní barevné varianty (bílá, šedá) je možné dodat při objednávce min 30ks.

# Noel S



Vysoce kvalitní čipy:



Vysoce kvalitní driver:



7 W 220-240 V IP 65 CRI >80 max +60°C min -20°C 30 000 h L70

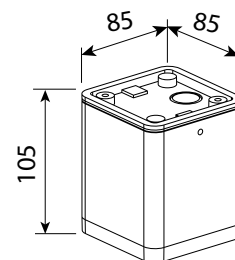

A+

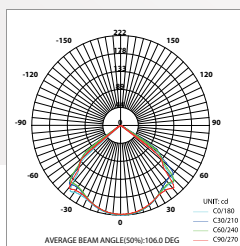

IP65 CE

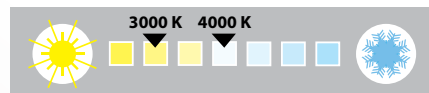

Barva	ML kód	ML typ	Výkon	Vyzař. úhel	Světelný tok	Teplota bílé	PF	IP	Cena Kč*
černá	ML-516.009.19.0	NOE-S-7W3000K-B	7 W	102°	550 lm	3000 K	≥0,5	65	921,-
	ML-516.010.19.0	NOE-S-7W4000K-B			590 lm	4000 K			

- Hliníkové pouzdro
- Plastový difuzor

\*Uvedené ceny jsou brutto velkoobchodní ceny v Kč bez DPH. Ostatní barevné varianty (bílá, šedá) je možné dodat při objednávce min 30ks.

# Cygnus

Vysoce kvalitní čipy:



Vysoce kvalitní driver:



8 W 220-240 V IP 65 CRI >80 max +60°C min -20°C 30000 h L70

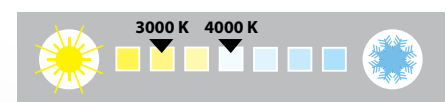
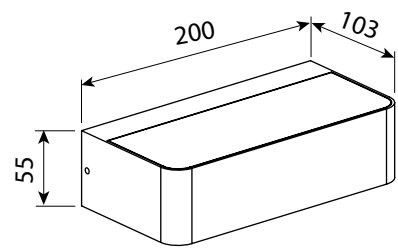

A+

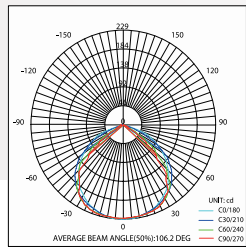

Barva	ML kód	ML typ	Výkon	Vyzař. úhel	Světelný tok	Teplota bílé	PF	IP	Cena Kč*
černá	ML-518.001.19.0	CYG-8W3000K-B	8 W	104°	910 lm	3000 K	≥0,5	65	1282,-
	ML-518.002.19.0	CYG-8W4000K-B			970 lm	4000 K			

- Hliníkové pouzdro
- Plastový difuzor

\*Uvedené ceny jsou brutto velkoobchodní ceny v Kč bez DPH. Ostatní barevné varianty (bílá, šedá) je možné dodat při objednávce min 30ks.

IP65 CE

# Kerberos

Vysoce kvalitní čipy:



Vysoce kvalitní driver:



9 W 220-240 V IP 65 CRI >80 max +60°C min -20°C 30000 h L70



- S pohybovým čidlem a senzorem denního světla

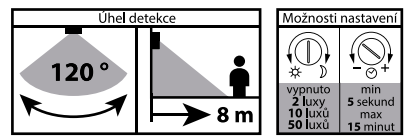
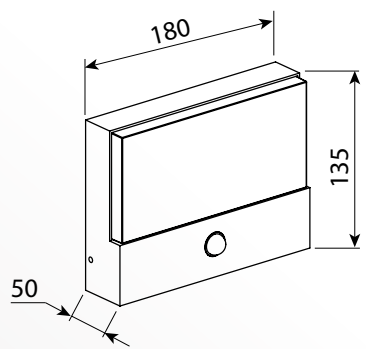

Možnosti nastavení

vypnuto	min 5 sekund
2 luxů	max 15 minut
10 luxů	
50 luxů	

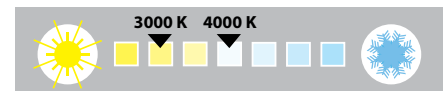

A+

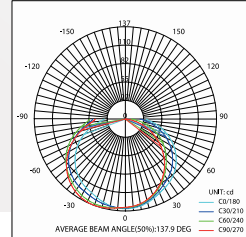
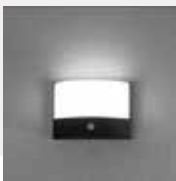

Barva	ML kód	ML typ	Výkon	Vyzař. úhel	Světelný tok	Teplota bílé	PF	IP	Cena Kč*
černá	ML-513.024.19.0	KER-9W3000K-B	9 W	90°	600 lm	3000 K	≥0,5	65	1372,-
	ML-513.025.19.0	KER-9W4000K-B			645 lm	4000 K			

- Hliníkové pouzdro
- Plastový difuzor

\*Uvedené ceny jsou brutto velkoobchodní ceny v Kč bez DPH. Ostatní barevné varianty (bílá, šedá) je možné dodat při objednávce min 30ks.

IP65 CE

# Draco R

Vysoce kvalitní čipy:



Vysoce kvalitní driver:



9 W 220-240 V IP 65 CRI >80 max +60°C min -20°C 30000 h L70

• Balení obsahuje výměnný kryt o průměru 145 mm a 95 mm

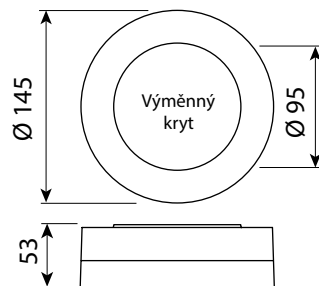

A+

• V balení jsou oba druhy krytů

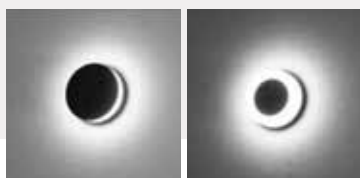

• kryt Ø 145 mm • kryt Ø 95 mm

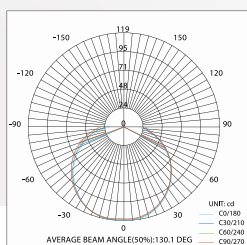

IP65 CE

Barva	ML kód	ML typ	Výkon	Vyzař. úhel	Světelný tok	Teplota bílé	PF	IP	Cena Kč*
černá	ML-513.016.19.0	DRA-R-9W3000K-B	9 W	50°/125°	230 lm / 470 lm	3000 K	≥0,5	65	1137,-
	ML-513.017.19.0	DRA-R-9W4000K-B			250 lm / 505 lm	4000 K			

• Hliníkové pouzdro  
• Plastový difuzor

\*Uvedené ceny jsou brutto velkoobchodní ceny v Kč bez DPH. Ostatní barevné varianty (bílá, šedá) je možné dodat při objednávce min 30ks.

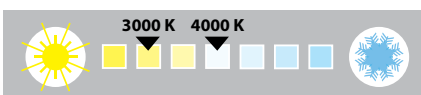

# Draco S

Vysoce kvalitní čipy:



Vysoce kvalitní driver:



9 W 220-240 V IP 65 CRI >80 max +60°C min -20°C 30000 h L70

• Balení obsahuje výměnný kryt o velikosti 135 x 135 mm a 86 x 86 mm

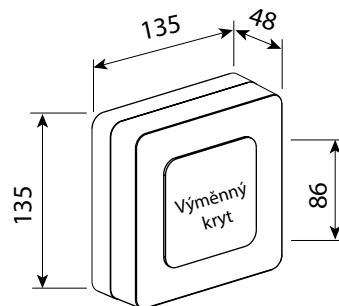

A+

• V balení jsou oba druhy krytů

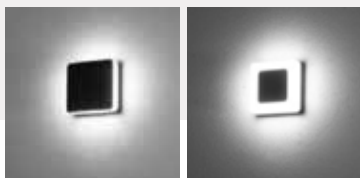

• kryt 135 x 135 mm • kryt 86 x 86 mm

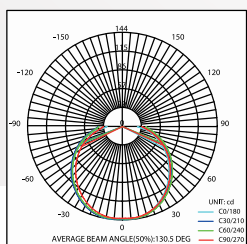

IP65 CE

Barva	ML kód	ML typ	Výkon	Vyzař. úhel	Světelný tok	Teplota bílé	PF	IP	Cena Kč*
černá	ML-513.018.19.0	DRA-S-9W3000K-B	9 W	50°/130°	270 lm / 560 lm	3000 K	≥0,5	65	1219,-
	ML-513.019.19.0	DRA-S-9W4000K-B			290 lm / 605 lm	4000 K			

• Hliníkové pouzdro  
• Plastový difuzor

\*Uvedené ceny jsou brutto velkoobchodní ceny v Kč bez DPH. Ostatní barevné varianty (bílá, šedá) je možné dodat při objednávce min 30ks.

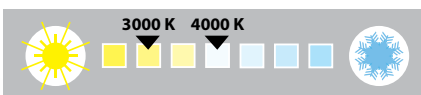

# Ursa R

Vysoce kvalitní čipy:



Vysoce kvalitní driver:



1,5 W

220-240 V

IP 65

CRI >80

max +60°C  
min -20°C

30000 h L70

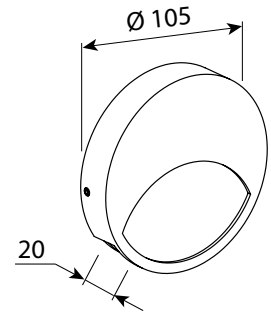

A+

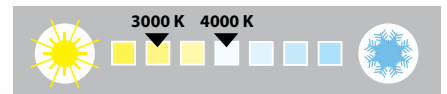
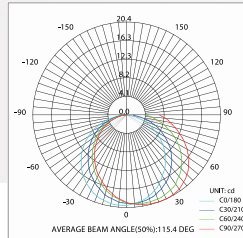

Barva	ML kód	ML typ	Výkon	Vyzař. úhel	Světelný tok	Teplota bílé	PF	IP	Cena Kč*
černá	ML-517.003.19.0	URS-R-1,5W3000K-B	1,5 W	110°	60 lm	3000 K	≥0,5	65	632,-
	ML-517.004.19.0	URS-R-1,5W4000K-B			65 lm	4000 K			

- Hliníkové pouzdro
- Plastový difuzor

\*Uvedené ceny jsou brutto velkoobchodní ceny v Kč bez DPH. Ostatní barevné varianty (bílá, šedá) je možné dodat při objednávce min 30ks.

IP65 CE

# Ursa S

Vysoce kvalitní čipy:



Vysoce kvalitní driver:



1,5 W

220-240 V

IP 65

CRI >80

max +60°C  
min -20°C

30000 h L70

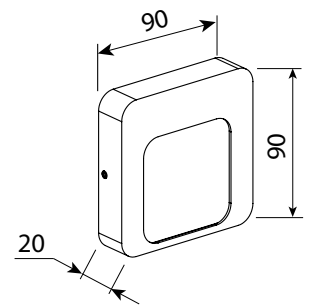

A+

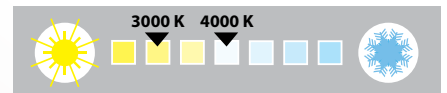
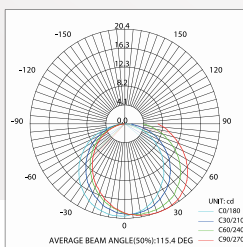

Barva	ML kód	ML typ	Výkon	Vyzař. úhel	Světelný tok	Teplota bílé	PF	IP	Cena Kč*
černá	ML-517.005.19.0	URS-S-1,5W3000K-B	1,5 W	110°	60 lm	3000 K	≥0,5	65	632,-
	ML-517.006.19.0	URS-S-1,5W4000K-B			65 lm	4000 K			

- Hliníkové pouzdro
- Plastový difuzor

\*Uvedené ceny jsou brutto velkoobchodní ceny v Kč bez DPH. Ostatní barevné varianty (bílá, šedá) je možné dodat při objednávce min 30ks.

IP65 CE

# Corona V

9 W
220-240 V
IP 65
CRI >80
max +60°C  
min -20°C
30 000 h L70



Vysoce kvalitní čipy:



Vysoce kvalitní driver:

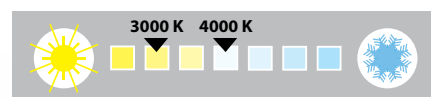
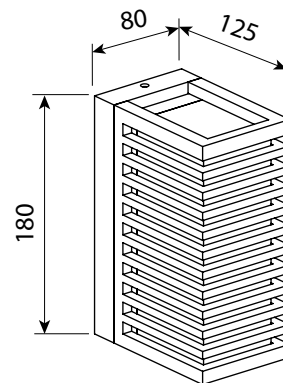

A+

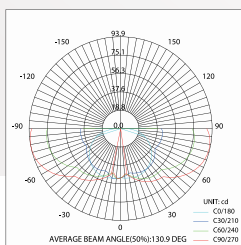
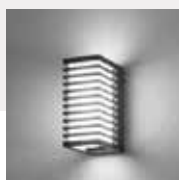

IP65 CE

Barva	ML kód	ML typ	Výkon	Vyzař. úhel	Světelný tok	Teplota bílé	PF	IP	Cena Kč*
černá	ML-513.020.19.0	COR-V-9W3000K-B	9 W	140°	345 lm	3000 K	≥0,5	65	1517,-
	ML-513.021.19.0	COR-V-9W4000K-B			375 lm	4000 K			

- Hliníkové pouzdro
- Plastový difuzor

\*Uvedené ceny jsou brutto velkoobchodní ceny v Kč bez DPH. Ostatní barevné varianty (bílá, šedá) je možné dodat při objednávce min 30ks.

# Corona H

9 W
220-240 V
IP 65
CRI >80
max +60°C  
min -20°C
30 000 h L70



Vysoce kvalitní čipy:



Vysoce kvalitní driver:

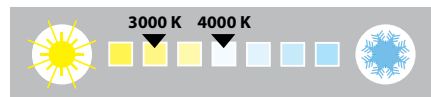
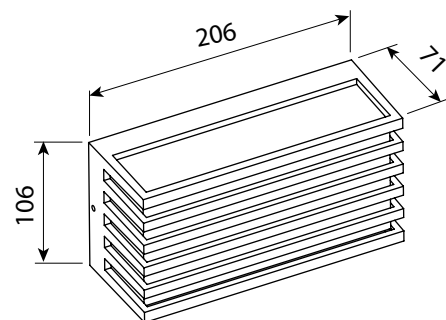

A+

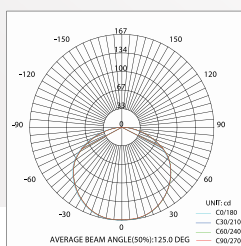
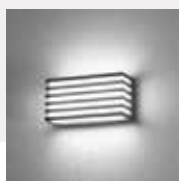

IP65 CE

Barva	ML kód	ML typ	Výkon	Vyzař. úhel	Světelný tok	Teplota bílé	PF	IP	Cena Kč*
černá	ML-513.022.19.0	COR-H-9W3000K-B	9 W	140°	265 lm	3000 K	≥0,5	65	1372,-
	ML-513.023.19.0	COR-H-9W4000K-B			285 lm	4000 K			

- Hliníkové pouzdro
- Plastový difuzor

\*Uvedené ceny jsou brutto velkoobchodní ceny v Kč bez DPH. Ostatní barevné varianty (bílá, šedá) je možné dodat při objednávce min 30ks.



# Ether

9 W 220-240 V IP 65 CRI >80 max +60°C min -20°C 30000 h L70



Vysoce kvalitní čipy:



Vysoce kvalitní driver:

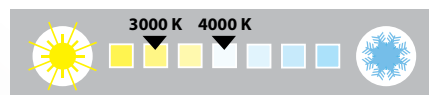
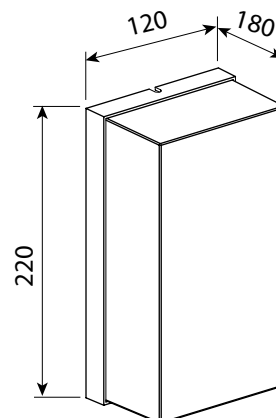

A+

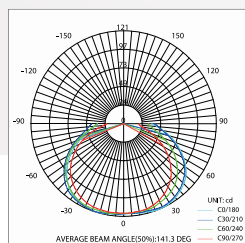

IP65 CE

Barva	ML kód	ML typ	Výkon	Vyzař. úhel	Světelný tok	Teplota bílé	PF	IP	Cena Kč*
černá	ML-513.030.19.0	ETH-9W3000K-B	9 W	135°	670 lm	3000 K	≥0,5	65	1408,-
	ML-513.031.19.0	ETH-9W4000K-B			720 lm	4000 K			

- Hliníkové pouzdro
- Plastový difuzor

\*Uvedené ceny jsou brutto velkoobchodní ceny v Kč bez DPH. Ostatní barevné varianty (bílá, šedá) je možné dodat při objednávce min 30ks.

# Leon

9 W 220-240 V IP 65 CRI >80 max +60°C min -20°C 30000 h L70



Vysoce kvalitní čipy:



Vysoce kvalitní driver:

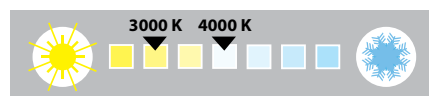
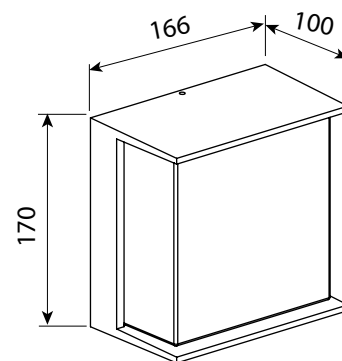

A+

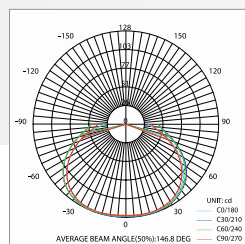

IP65 CE

Barva	ML kód	ML typ	Výkon	Vyzař. úhel	Světelný tok	Teplota bílé	PF	IP	Cena Kč*
černá	ML-513.034.19.0	LEO-9W3000K-B	9 W	140°	485 lm	3000 K	≥0,5	65	1517,-
	ML-513.035.19.0	LEO-9W4000K-B			520 lm	4000 K			

- Hliníkové pouzdro
- Plastový difuzor

\*Uvedené ceny jsou brutto velkoobchodní ceny v Kč bez DPH. Ostatní barevné varianty (bílá, šedá) je možné dodat při objednávce min 30ks.

# Kronos

9 W
220-240 V
IP 65
CRI >80
max +60°C  
min -20°C
30 000 h L70



Vysoce kvalitní čipy:



Vysoce kvalitní driver:

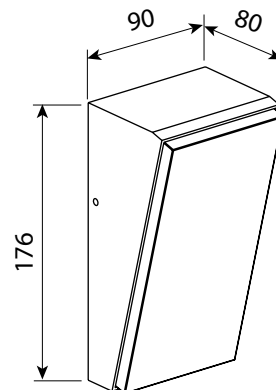

A+

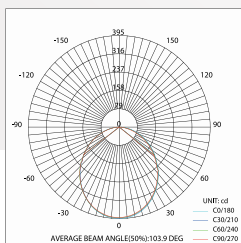

IP65 CE

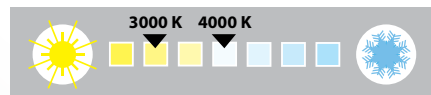

Barva	ML kód	ML typ	Výkon	Vyzař. úhel	Světelný tok	Teplota bílé	PF	IP	Cena Kč*
černá	ML-513.026.19.0	KRO-9W3000K-B	9 W	115°	660 lm	3000 K	≥0,5	65	1137,-
	ML-513.027.19.0	KRO-9W4000K-B			710 lm	4000 K			

- Hliníkové pouzdro
- Plastový difuzor

\*Uvedené ceny jsou brutto velkoobchodní ceny v Kč bez DPH. Ostatní barevné varianty (bílá, šedá) je možné dodat při objednávce min 30ks.

# Penelope

9 W
220-240 V
IP 65
CRI >80
max +60°C  
min -20°C
30 000 h L70



Vysoce kvalitní čipy:



Vysoce kvalitní driver:

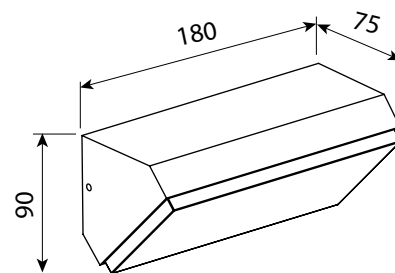

A+

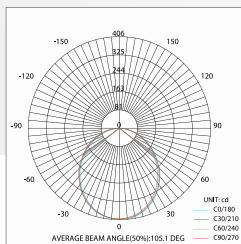

IP65 CE

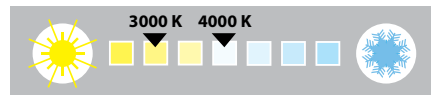

Barva	ML kód	ML typ	Výkon	Vyzař. úhel	Světelný tok	Teplota bílé	PF	IP	Cena Kč*
černá	ML-513.028.19.0	PEN-9W3000K-B	9 W	115°	635 lm	3000 K	≥0,5	65	1137,-
	ML-513.029.19.0	PEN-9W4000K-B			685 lm	4000 K			

- Hliníkové pouzdro
- Plastový difuzor

\*Uvedené ceny jsou brutto velkoobchodní ceny v Kč bez DPH. Ostatní barevné varianty (bílá, šedá) je možné dodat při objednávce min 30ks.

# Revos 2R

# Revos R

3 W
6 W
220-240 V
IP 65
CRI >80
max +60°C min -20°C
30000 h L70



Vysoce kvalitní čipy:



Vysoce kvalitní driver:

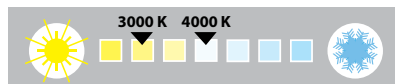
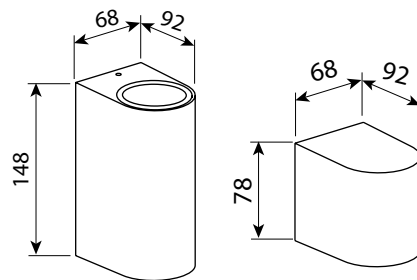

A+

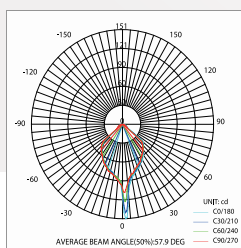

IP65 CE



Barva	ML kód	ML typ	Výkon	Vyžář. úhel	Světelný tok	Teplota bílé	PF	IP	Cena Kč*
černá	ML-518.005.19.0	REV-R-3W3000K-B	3 W	37°	140 lm	3000 K	≥0,5	65	857,-
	ML-518.006.19.0	REV-R-3W4000K-B			150 lm	4000 K			
černá	ML-518.009.19.0	REV-2R-6W3000K-B	6 W	37°	290 lm	3000 K	≥0,5	65	1047,-
	ML-518.010.19.0	REV-2R-6W4000K-B			310 lm	4000 K			

- Hliníkové pouzdro
- Plastový difuzor

\*Uvedené ceny jsou brutto velkoobchodní ceny v Kč bez DPH. Ostatní barevné varianty (bílá, šedá) je možné dodat při objednávce min 30ks.

# Revos 2S

# Revos S

3 W
6 W
220-240 V
IP 65
CRI >80
max +60°C min -20°C
30000 h L70



Vysoce kvalitní čipy:



Vysoce kvalitní driver:

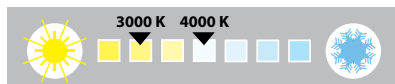
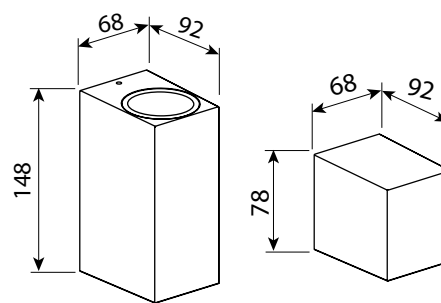

A+

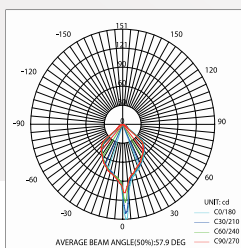

IP65 CE



Barva	ML kód	ML typ	Výkon	Vyžář. úhel	Světelný tok	Teplota bílé	PF	IP	Cena Kč*
černá	ML-518.003.19.0	REV-S-3W3000K-B	3 W	37°	140 lm	3000 K	≥0,5	65	857,-
	ML-518.004.19.0	REV-S-3W4000K-B			150 lm	4000 K			
černá	ML-518.007.19.0	REV-2S-6W3000K-B	6 W	37°	290 lm	3000 K	≥0,5	65	1047,-
	ML-518.008.19.0	REV-2S-6W4000K-B			310 lm	4000 K			

- Hliníkové pouzdro
- Plastový difuzor

\*Uvedené ceny jsou brutto velkoobchodní ceny v Kč bez DPH. Ostatní barevné varianty (bílá, šedá) je možné dodat při objednávce min 30ks.

# Verona 2R

# Verona R



7 W
14 W
220-240 V
IP 65
CRI >80
max +60°C min -20°C
30 000 h L70

Vysoce kvalitní čipy:



Vysoce kvalitní driver:

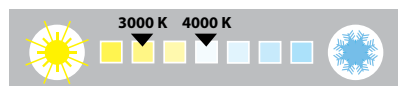
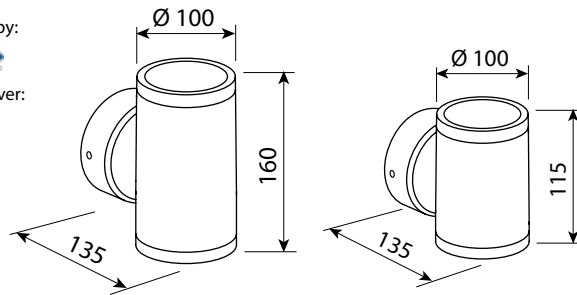

A+

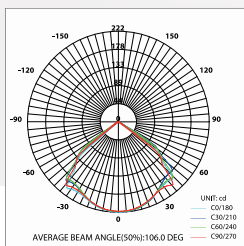

Barva	ML kód	ML typ	Výkon	Vyzař. úhel	Světelný tok	Teplota bílé	PF	IP	Cena Kč*
černá	ML-518.013.19.0	VER-R-7W3000K-B	7 W	102°	460 lm	3000 K	≥0,5	65	1155,-
	ML-518.014.19.0	VER-R-7W4000K-B			495 lm	4000 K			
černá	ML-518.015.19.0	VER-2R-14W3000K-B	14 W	102°	890 lm	3000 K	≥0,5	65	1490,-
	ML-518.016.19.0	VER-2R-14W4000K-B			955 lm	4000 K			

- Hliníkové pouzdro
- Plastový difuzor

\*Uvedené ceny jsou brutto velkoobchodní ceny v Kč bez DPH. Ostatní barevné varianty (bílá, šedá) je možné dodat při objednávce min 30ks.



# Verona 2S

# Verona S



7 W
14 W
220-240 V
IP 65
CRI >80
max +60°C min -20°C
30 000 h L70

Vysoce kvalitní čipy:



Vysoce kvalitní driver:

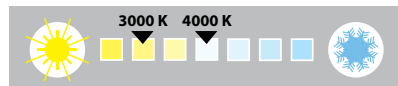
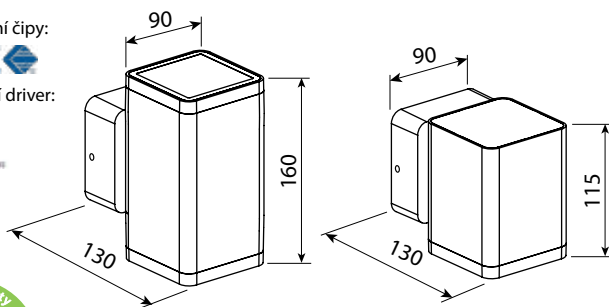

A+

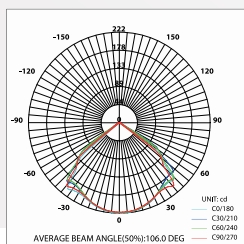

Barva	ML kód	ML typ	Výkon	Vyzař. úhel	Světelný tok	Teplota bílé	PF	IP	Cena Kč*
černá	ML-518.017.19.0	VER-S-7W3000K-B	7 W	102°	460 lm	3000 K	≥0,5	65	1201,-
	ML-518.018.19.0	VER-S-7W4000K-B			495 lm	4000 K			
černá	ML-518.019.19.0	VER-2S-14W3000K-B	14 W	102°	890 lm	3000 K	≥0,5	65	1535,-
	ML-518.020.19.0	VER-2S-14W4000K-B			955 lm	4000 K			

- Hliníkové pouzdro
- Plastový difuzor

\*Uvedené ceny jsou brutto velkoobchodní ceny v Kč bez DPH. Ostatní barevné varianty (bílá, šedá) je možné dodat při objednávce min 30ks.



# Framus W

Vysoce kvalitní čipy:



Vysoce kvalitní driver:



9 W    220-240 V    IP 65    CRI >80    max +60°C min -20°C    30000 h L70

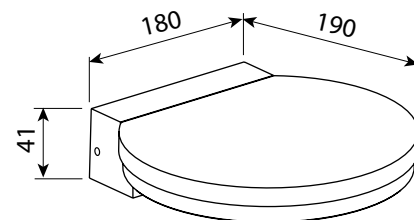

A+

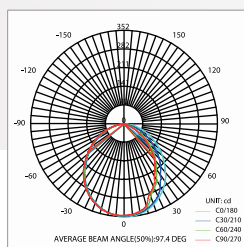
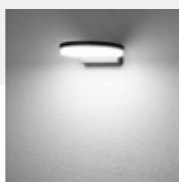

IP65 CE

Barva	ML kód	ML typ	Výkon	Vyzař. úhel	Světelný tok	Teplota bílé	PF	IP	Cena Kč*
černá	ML-513.032.19.0	FRA-W-9W3000K-B	9 W	115°	590 lm	3000 K	≥0,5	65	1137,-
	ML-513.033.19.0	FRA-W-9W4000K-B			635 lm	4000 K			

- Hliníkové pouzdro
- Plastový difuzor

\*Uvedené ceny jsou brutto velkoobchodní ceny v Kč bez DPH. Ostatní barevné varianty (bílá, šedá) je možné dodat při objednávce min 30ks.

# Framus P

Vysoce kvalitní čipy:



Vysoce kvalitní driver:

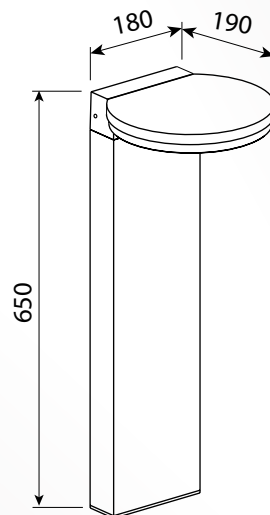

9 W    220-240 V    IP 65

CRI >80    max +60°C min -20°C    30000 h L70



3000 K    4000 K

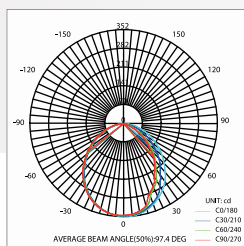

IP65 CE

Barva	ML kód	ML typ	Výkon	Vyzař. úhel	Světelný tok	Teplota bílé	PF	IP	Cena Kč*
černá	ML-515.011.19.0	FRA-P-9W3000K-B	9 W	115°	590 lm	3000 K	≥0,5	65	1706,-
	ML-515.012.19.0	FRA-P-9W4000K-B			635 lm	4000 K			

- Hliníkové pouzdro
- Plastový difuzor

\*Uvedené ceny jsou brutto velkoobchodní ceny v Kč bez DPH. Ostatní barevné varianty (bílá, šedá) je možné dodat při objednávce min 30ks.

## Thea



Vysoce kvalitní čip:



Vysoce kvalitní driver:

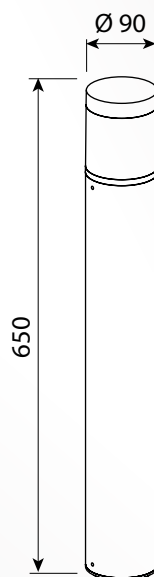

9 W

220-240 V

IP 65

CRI &gt;80

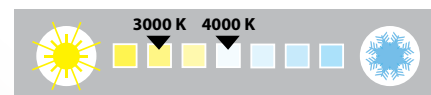

A+

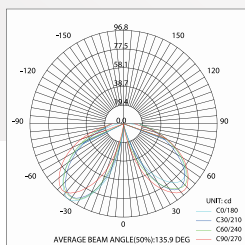

IP65



Barva	ML kód	ML typ	Výkon	Vyzař. úhel	Světelný tok	Teplota bílé	PF	IP	Cena Kč*
černá	ML-515.007.19.0	THE-9W3000K-B	9 W	115°	375 lm	3000 K	≥0,5	65	1625,-
	ML-515.008.19.0	THE-9W4000K-B			405 lm	4000 K			

- Hliníkové pouzdro
- Plastový difuzor

\*Uvedené ceny jsou brutto velkoobchodní ceny v Kč bez DPH. Ostatní barevné varianty (bílá, šedá) je možné dodat při objednávce min 30ks.

## Rhea



Vysoce kvalitní čip:



Vysoce kvalitní driver:

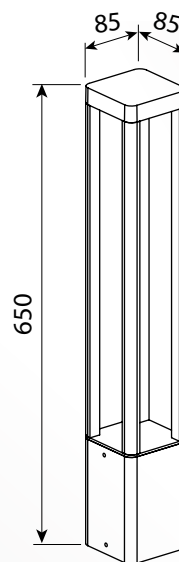

7 W

220-240 V

IP 65

CRI &gt;80

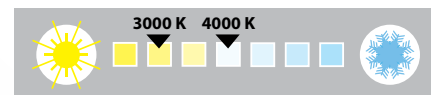

A+

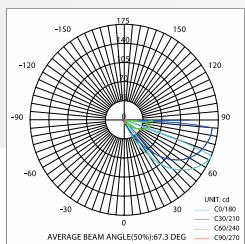

IP65



Barva	ML kód	ML typ	Výkon	Vyzař. úhel	Světelný tok	Teplota bílé	PF	IP	Cena Kč*
černá	ML-515.009.19.0	RHE-7W3000K-B	7 W	15°	330 lm	3000 K	≥0,5	65	1562,-
	ML-515.010.19.0	RHE-7W4000K-B			350 lm	4000 K			

- Hliníkové pouzdro
- Plastový difuzor

\*Uvedené ceny jsou brutto velkoobchodní ceny v Kč bez DPH. Ostatní barevné varianty (bílá, šedá) je možné dodat při objednávce min 30ks.

# Borg

Vysoce kvalitní čipy:



Vysoce kvalitní driver:



7 W 220-240 V IP 65 CRI >80 max +60°C min -20°C 30000 h L70

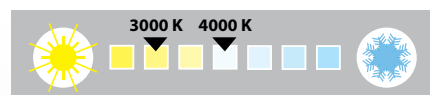
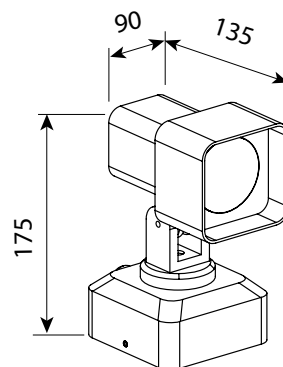

A+

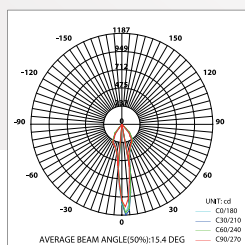

Barva	ML kód	ML typ	Výkon	Vyzař. úhel	Světelný tok	Teplota bílé	PF	IP	Cena Kč*
černá	ML-514.001.19.0	BOR-7W4000K-B	7 W	15°	430 lm	3000 K	≥0,5	65	1643,-
	ML-514.002.19.0	BOR-7W4000K-B			465 lm	4000 K			

- Hliníkové pouzdro
- Plastový difuzor

\*Uvedené ceny jsou brutto velkoobchodní ceny v Kč bez DPH. Ostatní barevné varianty (bílá, šedá) je možné dodat při objednávce min 30ks.

IP65 CE

# Kira

Vysoce kvalitní čip:



Vysoce kvalitní driver:



7 W 220-240 V IP 65

CRI >80 max +60°C min -20°C 30000 h L70

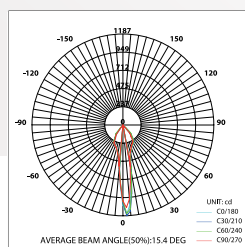
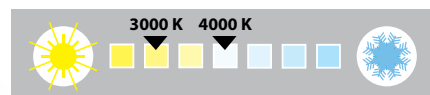
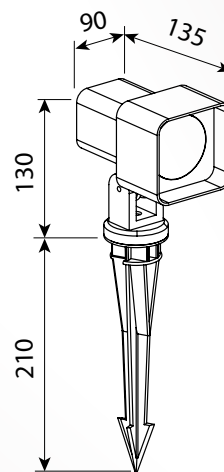

Barva	ML kód	ML typ	Výkon	Vyzař. úhel	Světelný tok	Teplota bílé	PF	IP	Cena Kč*
černá	ML-514.003.19.0	KIR-7W3000K-B	7 W	15°	430 lm	3000 K	≥0,5	65	1462,-
	ML-514.004.19.0	KIR-7W4000K-B			465 lm	4000 K			

- Hliníkové pouzdro
- Plastový difuzor

\*Uvedené ceny jsou brutto velkoobchodní ceny v Kč bez DPH. Ostatní barevné varianty (bílá, šedá) je možné dodat při objednávce min 30ks.

IP65 CE

 McLED s. r. o.  
Vídeňská 185, CZ - 252 50 Vestec  
Tel.: +420 220 184 800  
e-mail: office@mcled.cz  
www.mcled.cz

 Schmachtl GmbH  
Pummererstraße 36, A - 4020 Linz  
Tel.: +43 732 7646 718  
e-mail: office@mcled.at  
www.mcled.at

Více informací i aktuální **skladovou dostupnost**  
naleznete na webu [www.mcled.cz](http://www.mcled.cz)

Dotazy k produktům, technické záležitosti

Tel.: +420 220 184 881

Tel.: +420 220 184 894

Tel.: +420 220 184 827

Tel.: +420 220 184 886

E-mail: support@mcled.cz

Dotazy k objednávkám, obchodní záležitosti

Tel.: +420 220 184 820

Tel.: +420 220 184 889

Tel.: +420 220 184 828

E-mail: obchod@mcled.cz



Firma McLED s. r. o. si vyhrazuje právo na změnu cen,  
technické změny a vylepšení produktů McLED.

KAT-363.1\_06/21